

STCP 12-1 Issue ~~00~~4x Data Exchange Mechanism

STC Procedure Document Authorisation

Party	Name of Party Representative	Signature	Date
National Grid Electricity Transmission plc			
SP Transmission Ltd			
Scottish Hydro-Electric Transmission Ltd			
Offshore Transmission Owners			

STC Procedure Change Control History

Issue 1	18/03/2005	
Issue 2	29/03/2005	BETTA Go-Live version
Issue 3	31/01/2006	Incorporating PA034, PA037 and PA041
Issue 4	xx/xx/2010	Incorporating changes for Offshore Transmission & Removal of the Data Catalogue & Logical Interface Catalogue and adjusted Appendix E to C

Introduction

1.1 Overview

- 1.1.1 In the event of any inconsistency between this document and other STCPs, the provisions of those STCPs shall prevail until such times as amendments are agreed and the documents re-aligned.

1.2 Scope

- 1.2.1 This document applies to the formal exchange of data between Parties. A formal data exchange represents the transfer between Parties of data files or documents, as defined in the STCPs. All formal data exchanged between Parties is considered excepting the provision of data transferred via the SO-TO Datalink as defined in STCP4-1. These formal exchanges shall form the basis under which Parties meet their obligations under the STC and related procedures.
- 1.2.2 Full details and the context in which data is exchanged are contained within the respective STCPs.
- 1.2.3 This procedure applies to NGET and each TO.
- 1.2.4 For the purposes of this document, the TOs are:
- SPT
 - SHETL and
 - All offshore Transmission Licence holders as appointed from time to time by OFGEM

1.3 Objectives

- 1.3.1 The objectives of this document are to:
- provide the framework of data exchange for the processes that define the relationship between NGET and TO(s);
 - provide a consolidated list of the timing, content and transfer method as defined within other STC processes by presenting a unified listing of the information exchanges as identified within the individual STCPs;
 - define the responsibilities of NGET and TO in relation to the transfer of data between Parties;
 - define a process for maintaining consistency across all STC processes; and
 - to identify the data items to be exchanged and consolidates those data items into specific data exchange transfers.
- 1.3.2 Also, in the absence of specific individual STCP requirements to provide:
- a default audit process; and
 - a default data substitution process.

1.4 Background

- 1.4.1 Individual STCPs describe the detail of each data exchange. A framework for the exchange of data is required to ensure consistency across all STCPs. It is also necessary to source all the data exchanges within a single document to assist with consistency and co-ordinating the change management process across all STCPs.

- 1.4.2 The Services Capability Specification (SCS) are identified in the STC Section C. The provision of data within the SCS should be sufficient as necessary to allow NGET to meet its licence obligations.

2 Key Definitions

2.1 For the purposes of STCP12-1:

- 2.1.1 **Data Co-ordinator** means the contact(s) provided by each Party for the receipt and issuing of data under STCP12-1.
- 2.1.2 **Commissioning Data** means Normal Capability Limit data supplied for the purposes of allowing pre-commissioning system assessment to be carried out.
- 2.1.3 **Final Commissioning Data Status** means Commissioning data supplied by the TO for the purpose of allowing commissioning to take place. Once commissioning of the plant or apparatus has been completed, this data may be used for a short period (approximately 5 working days) while the TO updates the SCS to reflect and include all relevant data to allow NGET to comply with its licence conditions.
- 2.1.4 **Reactive Compensation Equipment** is not limited to Static Variable Compensators, Capacitors and Series or Shunt Reactors.

3 Procedure

3.1 Data Exchange

- 3.1.1 Each Party shall provide Data Co-ordinator(s) for the receipt and issuing of data. If appropriate, this can be achieved by allocating a different contact for specific transfers. The Data Co-ordinator will be referenced within each exchange.
- 3.1.2 When issuing data, the Data Co-ordinator shall ensure:
- the data to be transferred is in the format agreed between the transferring Parties;
 - all data required for a transfer flow is available;
 - the data is the latest version available unless a specific version of the data is requested;
 - that the contents of the exchange are validated by the originating Party as accurate and consistent with existing transfers and their STCPs;
 - transfers are recorded in accordance with the requirements of individual STCPs or, in the absence of such requirements, the default change control procedure defined in this document;
 - the information passed between STC Parties is limited to that permitted under the STC; and
 - the data is provided within the required timescale.
- 3.1.3 When receiving data, the Data Co-ordinator shall ensure:
- that the data submitted is complete in accordance with the relevant STCPs and fit for use (i.e. the data is not corrupted, drawings are clean and clear etc). For clarity, this does not extend to validating the content of the exchange;
 - the information held is updated in a timely manner;
 - that the data is distributed internally, notifying relevant persons of changes to that data and ensure that the data is available to them; and
 - that receipts are recorded in accordance with the requirements of individual STCPs or, in the absence of such requirements, the default change control procedure defined in this document.

3.2 Change Control

- 3.2.1 As data items are amended a new version of the data transfer file which holds the data item will be issued to all relevant Parties via the Data Co-ordinator.
- 3.2.2 In the absence of any specific STCP requirements, the nominated Data Co-ordinator for transfers within each Party shall be responsible for recording and acknowledging transfers as outlined below:
- 3.2.2.1 On issuing a transfer of information the issuing Data Coordinator shall:
- record the date and time of issue;
 - record the name of recipients of the exchange;
 - send an effective start date and time with the exchange;
 - retain a copy of the information provided;
 - manage the archiving of superseded data.
- 3.2.2.2 On receipt of an information transfer, the receiving Data Coordinator shall:
- acknowledge receipt of the file indicating their acceptance/rejection of the information contained therein. Acceptance of receipt is tacit agreement to use the information from the effective start date and time stated provided said date and time is sufficiently in advance of the receipt date and time to permit the recipient to sensibly act upon it. If not, the recipient shall raise the issue with the initiating Party indicating the earliest opportunity that it can be acted upon. If rejecting the exchange, a reason for the rejection shall be provided;
 - record the name of issuing contact along with date and time received;
 - and if exchange accepted, retain a copy of the latest information provided;
 - and if exchange accepted, ensure that the information held is updated and internally available in a timely manner;
 - internally, communicate to relevant working groups the revision to the information; and
 - manage the archiving of superseded data.

- 3.2.3 In the absence of STC or other STCP specific requirements previous submissions may be retained by each Party in accordance with internal data retention and archiving policies.

3.3 Audit

- 3.3.1 This section relates to the checking of the consistency of the data held by each Party against the formal submission process. Unless stated within individual STCPs, no regular audits of data are envisaged. The provisions of individual STCPs take precedence over the default arrangements outlined within this procedure.

- 3.3.2 Parties shall be responsible for their own internal audit procedures.

Where a Party has a concern over the accuracy or consistency of the data pertinent to them and held by another Party, they may request an audit of this information, in which case, they will provide an explanation as to why the audit is required. The timing and duration of any such audit will be by mutual consent. In the absence of agreement, a Party may raise a dispute in accordance with the STC.

- 3.3.3 When performing an audit, data consistency checks will be undertaken by the following points:

- 1) Each affected Party will provide to the instigating Party a record of the latest versions of information which they are using.
- 2) These records will be examined by the instigating Party who will provide confirmation or otherwise that the correct information is being utilised.
- 3) Where instances are discovered of inconsistent data new data transfer files will be issued and the recipient must notify when their existing files have been updated as described within the relevant STCP or within the guidelines outlined within this document.

3.4 Data Not Supplied

- 3.4.1 The provisions of individual STCPs take precedence over the default arrangements for the estimation of data outlined within this procedure.

- 3.4.2 If data is not supplied when required by an STCP then that data will be estimated if and when it is necessary to do so.

- 3.4.3 Such estimates will, in each case, be based upon data supplied previously under the STCPs or other such data that may be reasonably assumed for that purpose.

- 3.4.4 In the event of data not being supplied the proposed user shall notify the appropriate Data Co-ordinator of any estimated data, which it intends to use.

3.5 Supplementary Information Request (SIR)

- 3.5.1 This section provides for the formal exchange of supplementary information between NGET and the TO(s) which are not covered by the existing STC or STCP provisions but which may be required to better facilitate the meeting of licence, STC or other requirements identified by NGET or the TO(s).

- 3.5.2 Data exchanged under an SIR shall have the same status and standing as all other exchanges covered by the STC and related STCPs.

- 3.5.3 On identifying the need for supplementary data, the nominated Data Co-ordinator for the originating Party shall raise and send a formal request using the Supplementary Information Request form (see Appendix B).

- 3.5.4 The identifier for the SIR shall combine an identifier for the initiator (e.g. NGET, SPT, SHETL) followed by an incremental number.

- 3.5.5 Dates shall be provided for the formal response to the SIR and when the actual data provision is required (fields “Date Response Required” and “Originator Date for Data Provision”)
- 3.5.6 Where discussions have already taken place, the originating Party may also indicate the names of those resolution contacts.
- 3.5.7 The originator shall indicate on the form whether the information requested is required on an on-going basis and therefore requires an STCP amendment. In such cases it is the responsibility of the originating Party to raise such amendments as are necessary and in accordance with the change management process.
- 3.5.8 The recipient(s) shall assess and reply to an SIR both indicating acceptance and the limits (including form of transfer) to which such request can be met, or rejection of the request stating the basis for its rejection. The actual data may be transferred with the SIR response or at a later date as agreed and indicated on the SIR form.
- 3.5.9 On satisfactory transfer of the agreed data, and where there are no proposed STCP modifications, the SIR shall be closed. Where it has been indicated that an STCP modification is required the SIR shall remain in effect and timely updates to the data provided (in accordance with the SIR) until such times as the STCP modifications are incorporated into those documents.

3.6 STCP Information Request and Acknowledgement

- 3.6.1 Requests for information shall have the same status and standing as all other exchanges covered by the STC and STCPs and therefore require a response. This response will be provided on the same form as the request. Furthermore, the detail contained within the form will be dictated by the business context as described in the STCP that triggers the exchange of the form.
- 3.6.2 In the absence of a specific form within the STCP that requires the exchange, a form (see Appendix B) is available to either accept or reject the exchanged information. The detail contained within the form will be dictated by the business context within which the form is exchanged as described in the STCP that triggers the exchange of the form.

3.7 Data Co-ordinators

- 3.7.1 Data is exchanged between the Data Co-ordinators, appointed by each company. A change to a Data Co-ordinator will require the changing company to inform both other companies of that change.

3.8 Services Capability Specification for Offshore TO

- 3.8.1 Services Capability data for the all TOs is exchanged between the Data Co-ordinators using the agreed process between the individual TO and NGET. This process may be defined in the specific TO Services Capability Specification Guidance Notes to enable each TO to meet their obligations under the STC.

4 Maintenance of this STCP

- 4.1 As stated above, one objective of this document is to provide a process for maintaining consistency between STC Processes.
- 4.2 Where a change is proposed to an individual STCP, the following principal steps shall be followed to assess the impact on other STCPs and ensure consistency between documents.
- 4.3 For each change proposal that impacts on the transfer of any data items:
 - a) Check the Data Item List to see if the data item is already transferred
 - b) If the data item is already transferred, assess the impact against the Item Description, Standard Data Attributes and Detailed Attributes. Check the LIC to identify each instance that the data item is transferred and consider the impact on those entries. Add the entry to the LIC.
 - c) If the data item is not already transferred, then add the transfer to the Data Item List and a corresponding entry in the LIC.

Appendix A: Flow Diagram

Note that the Process Diagrams shown in this Appendix A are for information only. In the event of any contradiction between the process represented in this Appendix and the process described elsewhere in this STCP, then the text elsewhere in this STCP shall prevail.

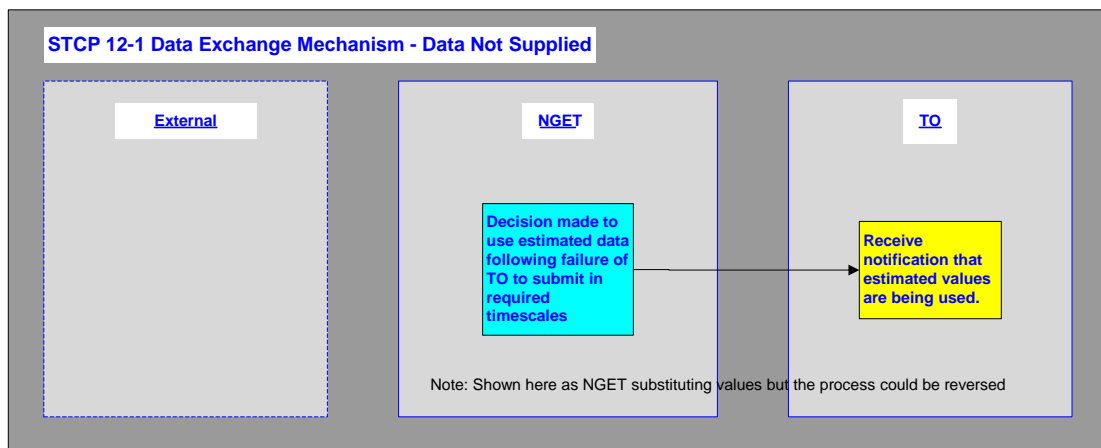
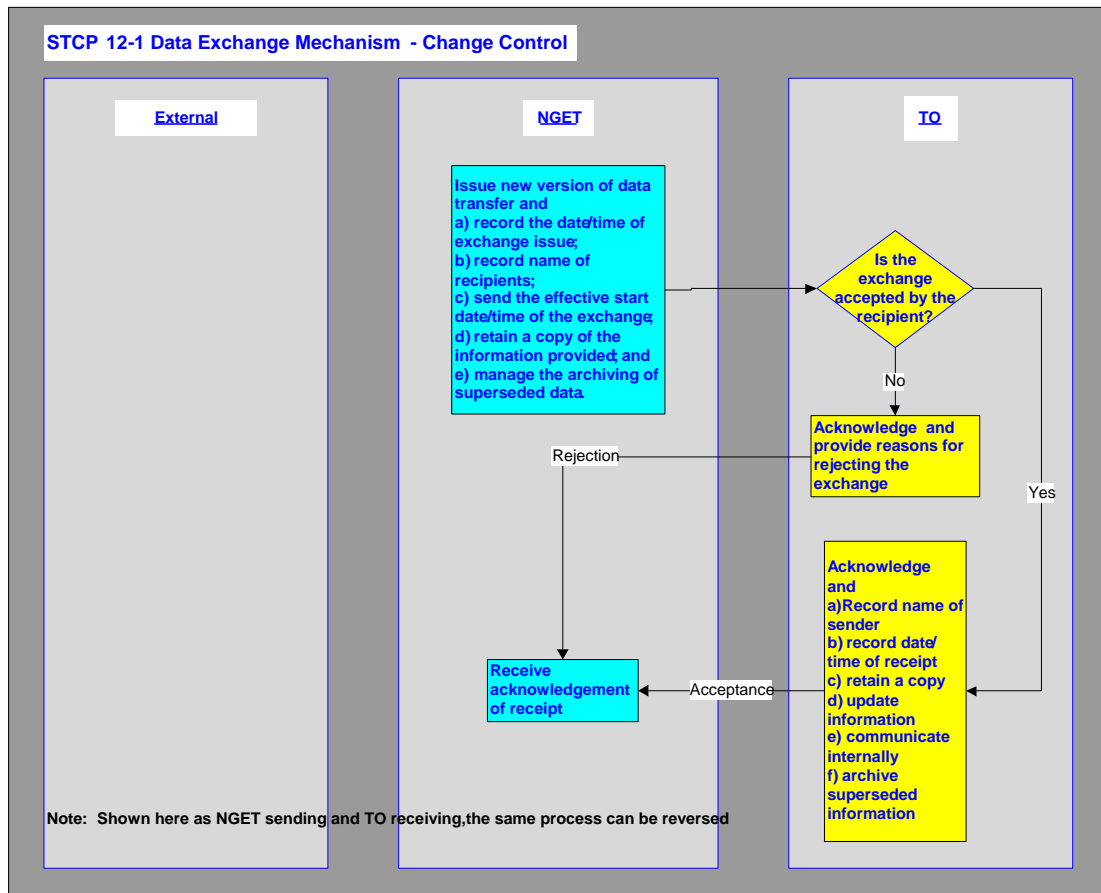

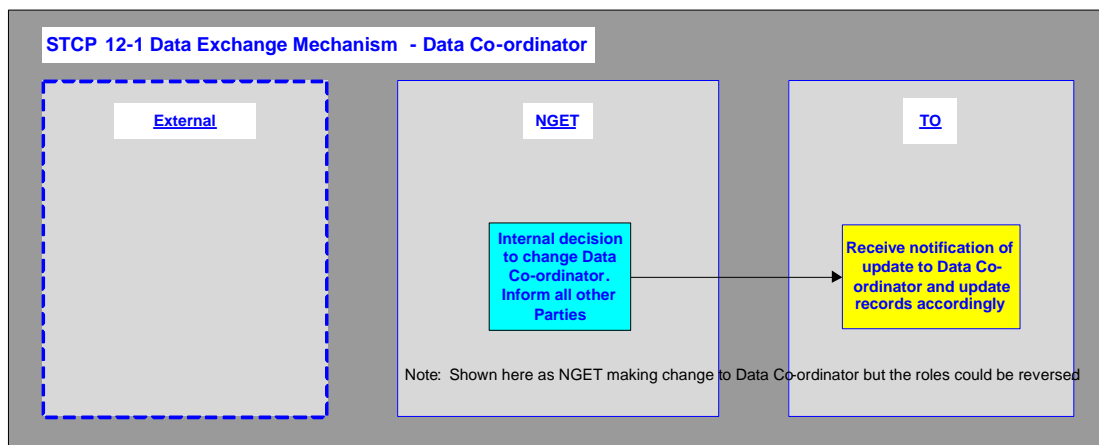
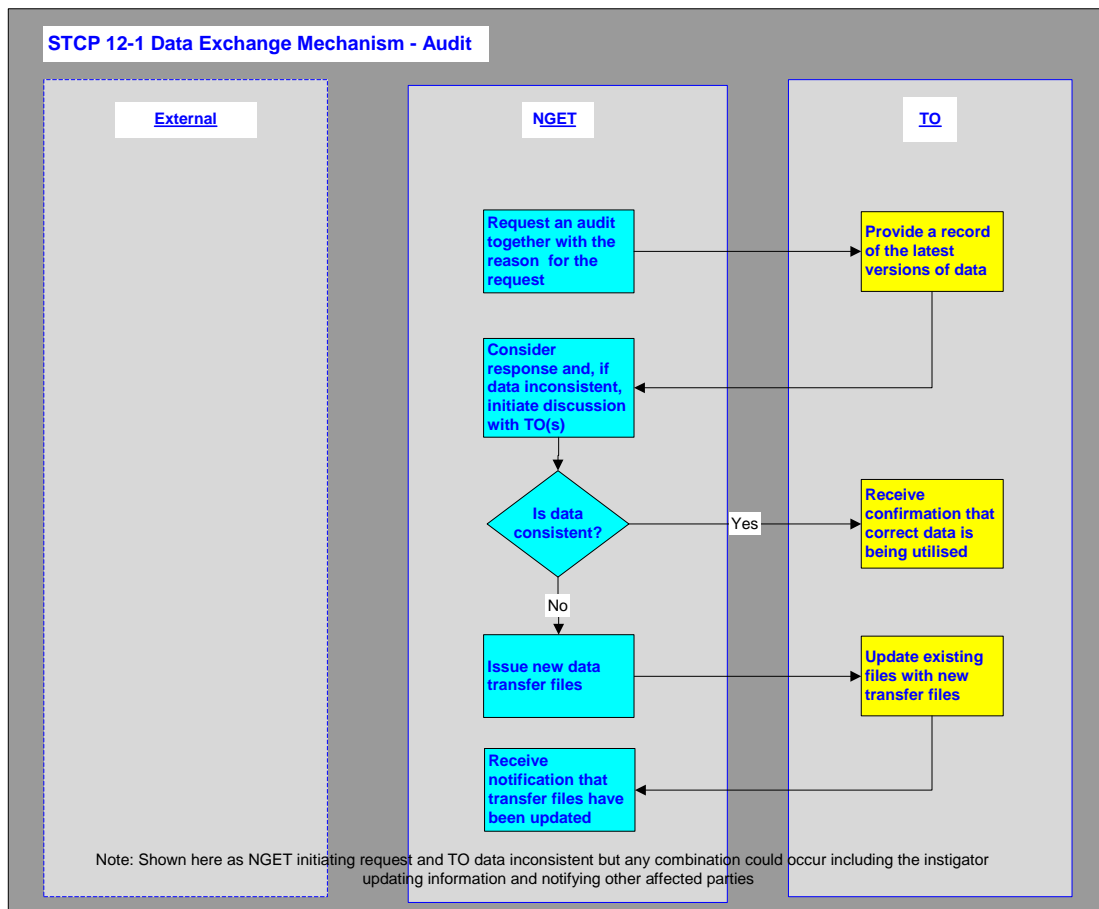

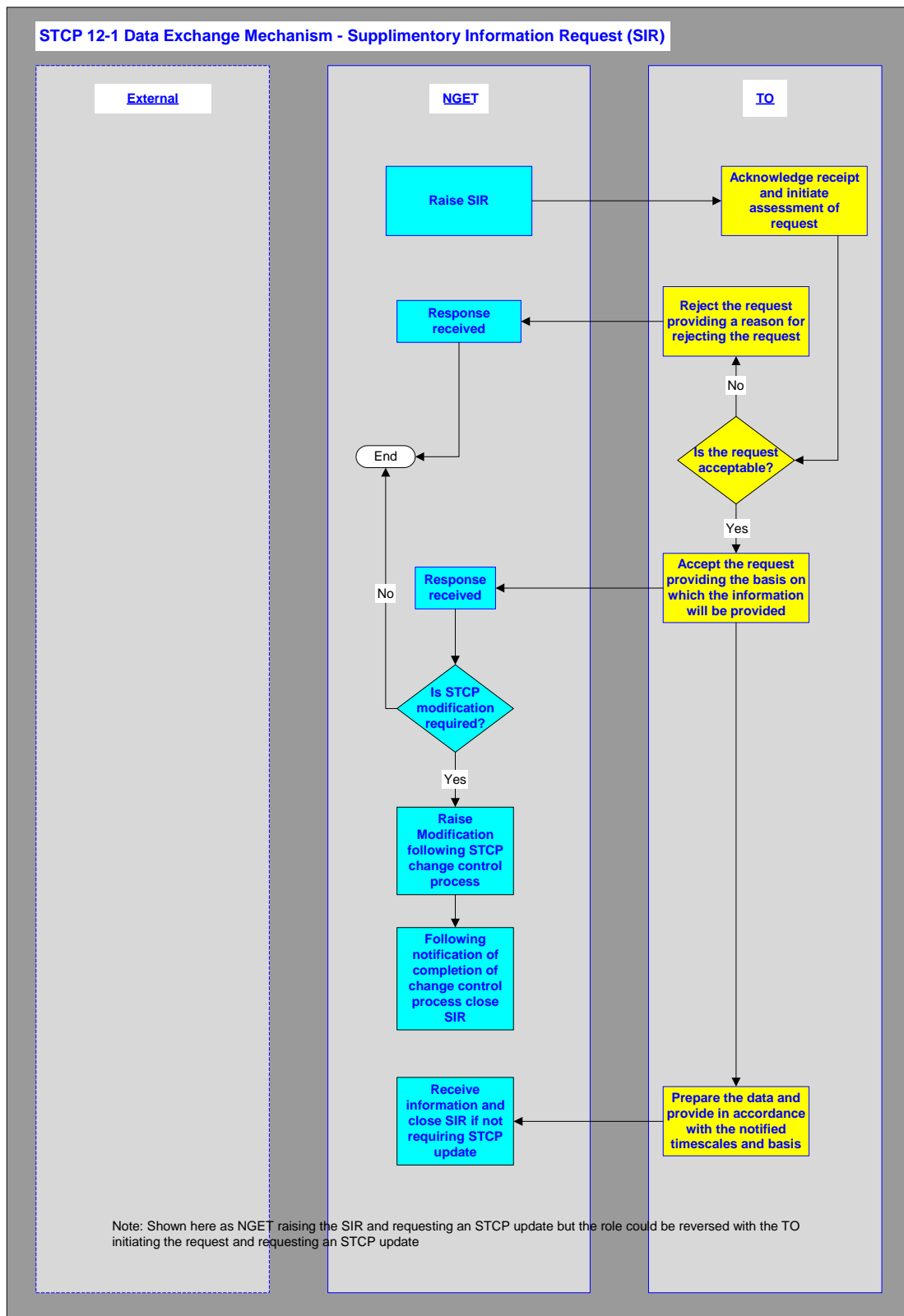

Appendix B: Standard Forms / Certificates**Supplementary Information Request (SIR)**

Originator Ref:		
From:		
To:		
Date:		
Date Response Required¹:		
Resolution Contacts – Originator:		
Recipient:		
Information Required (please state all data required):		
Is information to form part of an STCP?	Yes/No	
Purpose / Reason:		
Originator Date for Data Provision²:		
Response:		
Data effective from Date/Time³	Date:	Time:
Provision Target Date⁴:		Date SIR Closed:

¹ The date the instigator of the request requires a response from the receiving party as to whether the request can be serviced.

² The preferred date by which the instigator of the request requires the information.

³ If data provided as part of the response the date from which the data becomes effective.

⁴ The date by which the data will be provided.

STCP Information Request

STCP Information Request		STCP IR Reference⁵ (if any)
To:	From:	STCP Reference:
Date of Request:	Date Response required by:	Response to be sent to:
Information required (Please state all data required):		
STCP Information Response		
Date of Response:	Responder:	Response sent to:
Information Provided (describe all data and any attachments):		
Data effective from Date/Time	Date:	Time:

⁵ As a minimum, a prefix identifying the company shall be inserted

STCP Data Exchange Acknowledgement Form

STCP Data Exchange Acknowledgement	
Exchange Accepted/Rejected	
Data Transfer Number Received:	
Date of Receipt:	
Time of Receipt:	
Received By:	
Passed to:	
If Rejected then give reason:	

Appendix C: Services Capability Specification Guidance Notes for Offshore Transmission Owners

These Guidance Notes consists of 3 parts;

Part 1 Services Provided: a description of the services to be provided by the OFTO to NGET.

Part 2 Update Process: a description of the process for updating the OFTO SCS Data.

Part 3 Information to be provided: a description of the SCS Data to be provided by the OFTO to NGET together with example proforma to be used for data submission:

Section 1: Diagrams

Substation Operational Diagrams

Section 2: Circuits, Plant & Apparatus

Branch Data

ZPS Mutual Coupling Data

Circuit Breaker Data

Transformer Data

Reactive Compensation Equipment Data

Thermal Ratings Data

Section 3: Protection

Protection Policy

Protection & Automatic Switching Schedule

Generator Intertrip Schemes

Demand Intertrip Schemes

Section 4: System Availability

Substation Operational Guide

Section 5: Automatic Control Systems

Automatic Switching Schemes

**SERVICES CAPABILITY
SPECIFICATION**

GUIDANCE NOTES

FOR

OFFSHORE TRANSMISSION OWNERS

(VERSION 1)

Contents

<u>Part 1</u>	<u>Services Provided</u>
1	Background
2	Scope
3	Making Available Parts of the Transmission System
4	Update Process
<u>Part 2</u>	<u>Update Process</u>
Section 1	SCS Update Process
<u>Part 3</u>	<u>Information to be Provided</u>
Section 1	Drawings
Section 2	Circuits, Plant & Apparatus
Section 3	Protection
Section 4	System Availability
Section 5	Automatic Control Systems

Part 1 - Services Provided

1. Background

- 1.1. Section C Part 1 paragraph 2.1 of the SO/TO Code states that the TO shall provide services to NGET. These Transmission Services are defined as:
 - 1.1.1. making available those parts of its Transmission System which are intended for the purposes of conveying, or affecting the flow of, electricity, so that such parts are capable of doing so and are fit for those purposes;
 - 1.1.2. a means of enabling NGET to direct the configuration of those parts of that Transmission Owner's Transmission System made available to it and, consistent with such means, giving effect to any such direction from time to time; and
 - 1.1.3. a means of enabling NGET to obtain information in relation to that Transmission Owner's Transmission System which is needed by NGET to enable it to co-ordinate and direct the flow of electricity onto and over the GB Transmission System and, consistent with such means, providing information to NGET.
- 1.2. This document is the Services Capability Specification (SCS) Guidance Notes.
- 1.3. This document also describes the processes for updating the SCS.

2. Scope

- 2.1. The services described in this document will be provided in respect of the Transmission System owned by the Offshore Transmission Owner (TO).
- 2.2. For the avoidance of doubt, and as contemplated by the STC, this provides the definitive source of technical limits and parameters to which the system has been designed and should be operated in the absence of specific Operational Capability Limits (OCL).
- 2.3. Words and phrases in this SCS shall be construed in accordance with the STC except where the context otherwise requires.
- 2.4. The assets described in this document comprise the system of high voltage electric lines owned by the Offshore TO within its authorised area and includes electrical plant and meters owned or operated by such holders of a transmission licence in connection with the transmission of electricity.

3. Making Available Parts of the Transmission System

3.1. This describes in reasonable detail those parts of its Transmission System which the Offshore TO makes available to NGET in accordance with the STC and as referred to in Section 1.1.1 of this Services Capability Schedule. This section includes without limitation information on those parts of the Transmission System, and the parameters, conditions and levels to which they are normally capable of being made available, and the technical limits which that would normally be applied to the provision of this service.

3.2 This section provides an overview of the information to be provided and should be read in conjunction with STCP 12-1 Data Exchange Mechanism and the detailed specification provided in Part 3 of this document. If there are discrepancies between STCP12-1 and this document, STCP12-1 should be taken as being the description of the information to be provided.

3.3 Information Relating To The Transmission System~~Network~~ Configuration

3.3.1 This information comprises the ~~Substation Operational Diagram~~Operational diagram which provides a graphical, and connectivity view of their ~~transmission system~~network.

3.3.2 The diagrams referred to in 3.3.1 shall include all HV Apparatus and the connections to all external circuits. They will utilise STCP 10-1 (Asset and Nomenclature) standards of numbering, nomenclature and labelling.

3.3.3 The diagrams will provide a record, which is accurate in all material respects, of the layout and circuit interconnections, ratings & numbering, and nomenclature of HV Apparatus and related Plant.

3.3.4 The diagrams supplied under this Services Capability Specification will conform to the Offshore TO drafting practices and formats.

3.3.5 The diagrams supplied under this section are detailed in Part 3 Section 1 of this document.

3.4 Information Relating to Circuits, Plant and Apparatus

3.4.1 The Offshore TO will for each circuit in their Transmission system~~network~~ provide details of the name and operating voltage.

3.4.2 The Offshore TO will for each circuit in their Transmission system~~network~~ provide information to allow NGET to build models of the GB Transimission system~~network~~. This information shall include positive and zero sequence resistance, reactance and susceptance, all to a 100MVA base. It will also include the zero sequence resistance, reactance and susceptance for the mutual coupling between circuits.

3.4.3 The Offshore TO will provide pre-fault continuous, post-fault continuous and short term ratings for each circuit for the summer, spring/autumn and winter periods.

3.4.4 The Offshore TO will provide for each circuit breaker on their Transmission system~~network~~ details of fault capability.

3.4.5 The Offshore TO will provide for each transformer on their Transmission system~~network~~ details of rated voltages, ratings, voltage ratios, positive and zero sequence resistance, reactance and susceptance, all to a 100MVA base.

3.4.6 The Offshore TO will provide for each Reactive Compensation Equipment on their Transmission system~~network~~, details of rated voltages, ratings, losses and taps

3.4.7 The ratings referred to in this Section 3.4 that will be supplied for circuits, circuit breakers, transformers, and reactive control devices shall constitute the ~~Normal Capability Level~~Normal capability limit (NCL).

3.4.8 Information relating to the NCLs of circuits, which may be made up of overhead and underground sections, will be provided as a composite figure.

3.4.9 For the avoidance of doubt, and as contemplated by the STC, the ~~Operational Capability Level~~Operational capability limit (OCL) will be equal to the NCL unless otherwise notified by the Offshore TO.

3.4.10 It is recognised that normal protection and DAR operation following transient faults will temporarily remove the affected plant from operation. This is part of the normal capability of plant and circuits.

3.4.11 The information supplied under this section is detailed in part 3 Section 2 of this document.

3.5 Protection Operation and Auto-Switching

3.5.1 The Offshore TO will provide information in respect the Offshore TO protection policy in respect of the equipment made available. NGET must operate the Offshore TO Transmission system~~network~~ in accordance with this policy unless authorised to deviate from this policy.

3.5.2 The Offshore TO will provide details of protection and automatic switching operations in schedule format for each circuit.

3.5.3 This schedule will be to provide details of line protection equipment, protection telecommunication services, protection signalling equipment, Intertripping equipment, circuit breaker tripping initialisation, overall clearance times, load limitations, synchronising facilities, DAR schedules and ferroresonance protection.

3.5.4 The information supplied under this section is detailed in Part 3 Section 3 of this document.

3.5.5 The Offshore TO will provide information in respect of System, Generator and Demand Intertripping Schemes made available.

3.6 System Availability

3.6.1 The Offshore TO shall provide details of any transmission system planning derogations.

3.6.2 Where planning derogations impact upon connections, they shall normally be listed in the Connection Site Specification, as set out in the STC Section D2.2.7.3.

3.6.3 The Offshore TO will provide details of any technical limits or other operational matters which apply across its Transmission System, either for a full system or for outage conditions, which are not detailed in other sections.

3.6.4 The Offshore TO will provide details of any technical limits or other operational matters which apply on its Transmission System on a substation by substation basis, either for a full system or for outage conditions.

3.6.5 These technical limits and other operational matters shall be treated by NGET as NCLs, and NGET shall ensure that these NCLs are not breached.

3.6.6 The information supplied under this section is detailed in Part 3 Section 4 of this document.

4. Update Process

4.1 SCS Changes

4.1.1 To allow NGET to operate the system in a safe and secure manner, the Offshore TO shall ensure that the data provided to NGET under the SCS is properly controlled, maintained and ensure that changes are notified within reasonable timescales. The process described more fully in Part 2 Section 1 of this document explains the SCS change mechanism.

4.1.2 Changes to the dataset contained in the SCS will be initiated as a consequence of changes made to the TO Transmission systemnetwork. Factors, which initiate changes, will include:

- Investment Plans involving commissioning or decommissioning of assets
- Investment Plans not tied to commissioning or decommissioning of assets i.e. a variation to Transmission Services
- The final removal of assets from drawings within the SCS which are not available for operational purposes or available for configuration by NGET after removal from safety distance
- Agreed Form changes
- Agreed refreshes of data, consolidating and confirming previous changes
- Typographical error corrections

4.1.3 The data will be regarded first as Commissioning Data when sent to NGET, and then as SCS Data when incorporated into the SCS under the process described in Part 2 below. For the avoidance of doubt, commissioning data will only become SCS data once the Acceptance Certificate, Part 2 has been signed.

5. Automatic Control Management Systems

5.1. SCS Changes

5.1.1. The Offshore TO will provide information in respect of the Offshore TO automatic control management system in respect of the equipment made available. NGET must operate the Offshore TO Transmission systemnetwork in accordance with this policy unless authorised to deviate from this policy.

5.1.2. The Offshore TO will provide details of automatic control management system operations in schedule format for each circuit.

5.1.3. This schedule will be to provide details of automatic control management equipment, telecommunication services if relevant, switching signalling equipment and sequence mal-operation.

5.1.4. The information supplied under this section is detailed in Part 3 Section 5 of this document.

Part 2 – Update Process

Section 1 - SCS Update Process

1 SCS Updates

1.1 Process – General

- 1.1.1 The data contained in the SCS will be the definitive source of data supplied by the Offshore TO and to be used by NGET in the operation of the Offshore TO Transmission System.
- 1.1.2 Changes to the dataset contained in the SCS will arise from the Investment Planning process and from agreed changes to the Form. A general data refresh or correction of typographical errors may also take place pursuant to the investment planning process.
- 1.1.3 Changes to the SCS data will be initiated when data contained in the SCS changes.
- 1.1.4 For every data exchange intimated to NGET, pursuant to the SCS, the following records will be maintained:
- a record will be kept of the date and time of issue of the data
 - the name of senders and recipients of the data will be recorded
 - the proposed effective date and time will be sent along with the notification
 - a copy of the information sent will be retained by the Offshore TO
- 1.1.5 On receipt of a data change, NGET will acknowledge receipt of the revised SCS data. Acceptance of receipt is agreement to use the information from the proposed start date. If NGET rejects the data, then a reason shall be provided.

1.2 Data Updates – Commissioning

- 1.2.1 Within the time frames specified in STCP 19-4 Commissioning and Decommissioning and ahead of on-load testing, the Offshore TO will send to NGET, data for the scheme that is to be commissioned.
- 1.2.2 Data sent before on-load testing will be Commissioning Data. This data will not describe any assets that are being made available, but will form the Offshore TO estimate created in line with good industry practice of the parameters and technical limits relating to the scheme that it is proposed will be commissioned. This data will therefore be suitable, for example, for system studies following commissioning of the scheme. This data will also form limits that should be adhered to by NGET during on-load commissioning.

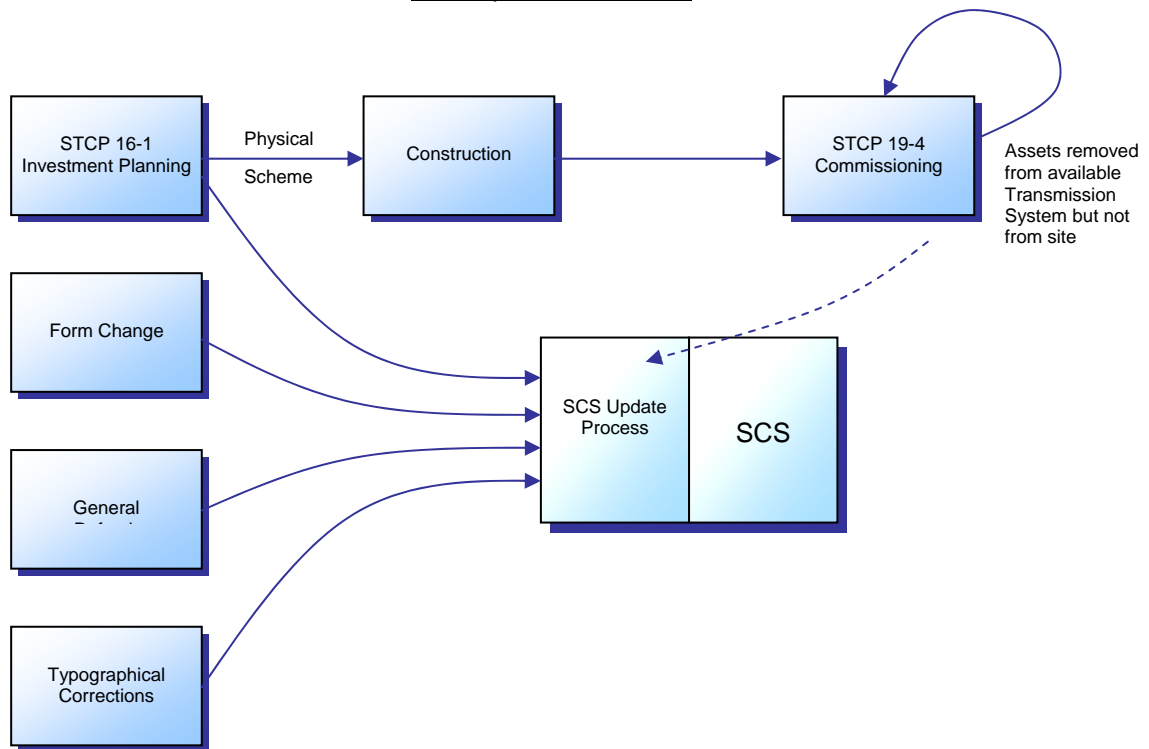
SCS Update Processes

1.2.3 For the avoidance of doubt, at any stage during the commissioning process, change data sets sent subject to this process may be updated.

1.2.4 On successful completion of the on-load testing, and when Part 2 of the Acceptance Certificate is signed (STCP 19-4 refers), the data will now have Final Commissioning Data Status and becomes available for operational service and configuration to NGET.

1.2.5 At this stage the data becomes SCS data.

1.2.6 However, and as a practical matter, while the data is now SCS data – the data is not contained in the main body of the SCS.

1.2.7 As soon as reasonably practicable following the signing of the Acceptance Certificate Part 2, the Offshore TO will:

- provide any further updates to the SCS data in respect of any changes to the data which have occurred as a result of the commissioning process, and
- incorporate the data referred to in the main body of the SCS.

1.3 Data Updates – Decommissioning

- 1.3.1 For the avoidance of doubt, any items of plant which are shown on the ~~Substation Operational Diagram~~ Operational diagrams which are shown as not connected to the Offshore TO ~~transmission system~~ network, do not form part of the system which the Offshore TO makes available to NGET.
- 1.3.2 When a Decommissioning Report is signed and declaration *A on the Decommissioning Report is indicated, then the associated Plant and Apparatus will remain in the relevant drawings in SCS but not available for operational use by NGET. If declaration *B on the Decommissioning Report is indicated, then the relevant data corresponding to the associated Plant and Apparatus will be removed from the SCS.
- 1.3.3 At this stage the assets ceases to be available, and the changes are made to the SCS data.
- 1.3.4 The Offshore TO will update the main body of the SCS as in section 1.1 above.

1.4 Data Updates – General Refresh / Typographical Corrections

- 1.4.1 For general data refreshes/typographical corrections to the data, the Offshore TO will update the main body of the SCS as per section 1.1 above.

Part 3 – Information to be provided

Section 1 – Diagrams

Information / data to be supplied

Items	Description	Reference	STCP12-1 Data Item List Reference
Substation Operational Diagram <u>Operational diagram</u>	A drawing which includes all HV Apparatus and the connections to all external circuits, with all numbering, nomenclature and labelling	Part 3 Section 1.1	126

General Remarks

~~Substation Operational Diagram~~ Operational diagrams form the definitive drawings of the Offshore TO ~~network~~ Transmission system.

~~Substation Operational Diagram~~ Operational diagrams may show items which are not connected to the Offshore TO Transmission system ~~network~~, including:

- Plant and Apparatus owned by the Offshore TO but not connected to the Offshore TO Transmission system ~~network~~
- Access roads

For the avoidance of doubt, none of the items shown which are not connected to the Offshore TO Transmission system ~~network~~ form part of the system that the Offshore TO makes available to NGET.

Additionally, these diagrams will show Plant and Apparatus owned by Users. For the avoidance of doubt, the SCS is not the definitive statement of either:

- The boundaries (control or commercial) between the Offshore TO Transmission system ~~network~~ and that of the Users, or
- Layout and configuration of the User's Plant and Apparatus

Section 2 – Circuits, Plant & Apparatus

Information / data to be supplied

Items	Description	Reference	STCP12-1 Data tem List Reference
Branch Data	Circuit name	Part 3 Section 2.1	162
	Node names		
	Rated / operating voltage		
	Post fault continuous ratings		
	Positive phase sequence resistance (R1)		
	Positive phase sequence reactance (X1)		
	Positive phase sequence susceptance (B1)		
	Zero phase sequence self resistance (R0)		
	Zero phase sequence self reactance (X0)		
	Zero phase sequence self susceptance (B0)		
	Circuit lengths (km)		
	NGET line code		
Mutual Coupling Data	Circuit 1 name	Part 3 Section 2.2	162
	Circuit 2 name		
	Node names		
	Zero sequence mutual resistance (R0m)		
	Zero sequence mutual reactance (X0m)		
	Zero sequence mutual susceptance (B0m)		
	Parameters describing percentages of line coupled		
Circuit Breaker Data	Location / substation	Part 3 Section 2.3	163
	Circuit breaker name		
	Voltage		
	Manufacturer / Model / Type		
	Year commissioned		
	Assumed operating times:		
	Circuit breaker (mS)		
	Minimum protection & trip (mS)		
	Total (mS)		
	Rated RMS continuous current (A)		
	3 Phase:		
	Fault rating RMS symmetrical (MVA)		
	Fault break rating RMS symmetrical (kA)		
	Fault break rating RMS asymmetrical (kA)		
	Fault break rating MS peak asymmetrical (kA)		

Items	Description	Reference	STCP12-1 Data Item List Reference
Circuit Breaker Data (continued)	1 Phase:	Part 3 Section 2.3	163
	Fault rating RMS Symmetrical (MVA)		
	Fault break rating RMS Symmetrical (kA)		
	Fault break rating RMS Asymmetrical (kA)		
	Fault break rating RMS Peak Asymmetrical (kA)		
Transformer Data	Location / substation	Part 3 Section 2.4	164
	Transformer name		
	Voltage HV (kV)		
	Voltage LV (kV)		
	Node names		
	Rating (MVA)		
	PPS parameters: R1 (%100MVA)		
	PPS parameters: X1 (%100MVA)		
	ZPS parameters: R0 (%100MVA)		
	ZPS parameters: X0 (%100MVA)		
	Taps: Tap low (%)		
	Taps: Tap high (%)		
	Taps: Tap step size (%)		
	Winding arrangement (Vector group)		
	Tap changer type		
	Earthing method (direct, resistance or reactance)		
	Earth impedance (ohms)		
	NGET line code		
Reactive Compensation Equipment Data	Location / substation	Part 3 Section 2.5	166
	Type of equipment (reactor, capacitor, SVC)		
	Equipment name / number		
	Voltage (kV)		
	Node name		
	Rating (MVAr)		
	Electrical parameters		
	Connection		
Short-Term Ratings Data	Composite thermal rating sheets	Part 3 Section 2.6	162

Remarks

Ratings

Under Branch Data (Part 3, Section 2.1), NGET will insert the appropriate NGET line code. Under Transformer Data (Part 3, Section 2.4), NGET will insert the appropriate line code. The Offshore TO will not change this information in line with Good Industry Practice.

Fault Levels

NGET are permitted to operate the Offshore TO Transmission System up to 100% of the fault capabilities provided in Part 3, Section 2.3.

Section 3 – Protection

Information / data to be supplied

Items	Description	Reference	STCP12-1 Data Equipment Item List Reference
Protection Policy	Information in respect of Offshore TO Protection Policy	Part 3 Section 3.1	
132kV Protection and Automatic Switching Data	Single Line Diagram	Part 3 Section 3.2	168, 169, 171, 172, 178
	Line protection equipment		
	Protection telecommunication services		
	Protection signalling equipment		
	Intertripping equipment		
	Intertripping & protection unstabilisation equipment		
	Circuit breaker tripping initiation		
	Line fault overall clearance times		
	Load limitations		
	Circuit breakers fail protection		
	Synchronising facilities		
	Auto switching (DAR) schedules		
Generator Intertrip Schemes	Descriptions of Generator Intertrip Schemes	Part 3 Section 3.3	173
Demand Intertrip Schemes	Description of Demand Intertripping Schemes	Part 3 Section 3.4	174

Section 4 – System Availability

Information / data to be supplied

Items	Description	Reference	STCP12-1 Data Equipment Item List Reference
Planning Derogations	Derogations from the GBSQSS which pertain to the general transmission system. Details of site specific derogations will be specified in the appropriate Connection Site Specification.	Part 3 Section 4.1	
General Limitations	Limitations to the operation of the Offshore TO equipment which applies generally across the system and which has not been identified via the parameters and technical limits given above.	Part 3 Section 4.2	
Substation Operating Guides	Limitations to the operation of the Offshore TO equipment which is specific to an individual substation, identifying the equipment, the substation and the technical limitations.	Part 3 Section 4.3	179

Section 5 – Automatic Control Management Systems

Information / data to be supplied

Items	Description	Reference	STCP12-1 Data Equipment Item List Reference
Auto Control Policy	Information in respect of Offshore TO Automatic Switching Scheme	Part 3 Section 5.1	
Auto Control Scheme	Make, Model & Variations of Scheme	Part 3 Section 5.2	172
	Scheme Operational Sequences & Timings		
	Scheme Operational Equipment Diagram		
	Scheme Logic diagram		
	Scheme Mal-operation Contingency Capability & Limitations	Part 3 Section 5.3	

Substation Operational Diagram EXAMPLE

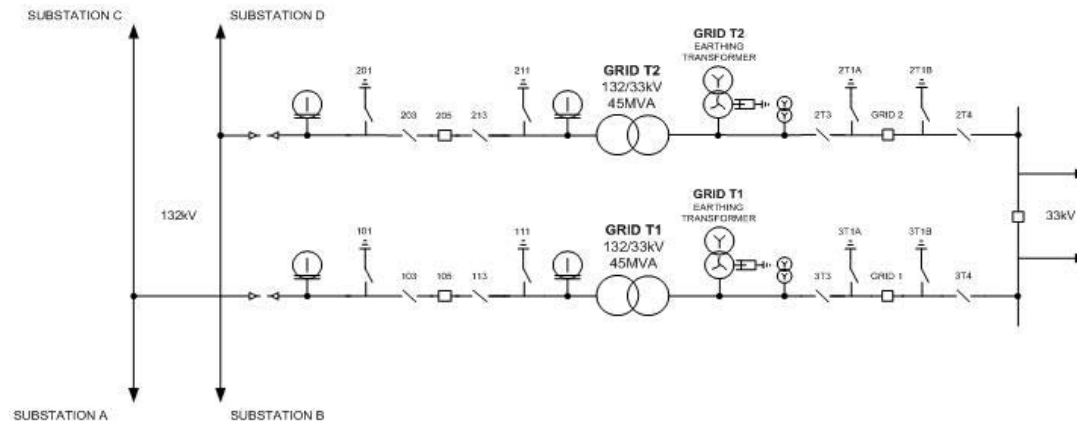

Guidance Notes Reference: Part 3 Section 1.1

Company Logo	Drawn	Initials	Date	Title	WINDFARM XXX SUBSTATION 132/33kV Substation
	Checked		xx/xx/xx	Location	XXXXXXXXXXXXXXXXXXXXXXXXXXXX
	Approved		xx/xx/xx	Drawing No.	XXXXXXXXXXXXXXXXXXXXXXXXXXXX
	Authorised		xx/xx/xx	Rev.	A
	Status				

EXAMPLE

Offshore TO Name

Services Capability Specification

Guidance Notes Reference: Part 3 - 2.1 Branch Data

Node 1	Node 2	Voltage	Circuit	PPS PARAMETERS			ZPS PARAMETERS			Maximum Continuous Ratings			Lengths (km)	NGET Line Code
		kV		R1	X1	B1	R0	X0	B0	Winter	Spr/Aut	Summer		
				%100MVA	%100MVA	%100MVA	%100MVA	%100MVA	%100MVA	MVA	MVA	MVA		
Name	Name	132	Location A - Location B	0.7910	3.9010	0.9940	2.0240	10.1750	0.0000	146	146	146	18.30	C123
			EXAMPLE											

EXAMPLE

Offshore TO Name

Services Capability Specification

Guidance Notes Reference: Part 3 - 2.2 ZPS Mutual Coupling Data

Circuit 1 Name	Circuit 1 Node 1	Circuit 1 Node 2	Coupled to	Circuit 2 Node 1	Circuit 2 Node 2	R _{0M}	X _{0M}	B _{0M}
			Circuit 2 Name					
			%100MVA					
Circuit A	Name	Name	Circuit B	Name	Name	0.3019	0.7436	0.0199
			EXAMPLE					

EXAMPLE

Offshore TO Name

Services Capability Specification

Guidance Notes Reference: Part 3 - 2.3 Circuit Breakers

Location	Name	Voltage	Maker	Model	Type	Year Commissioned	Assumed Operating Times			Continuous Rating (A)	3 Phase				1 Phase			
							Circuit Breaker (mS)	Minimum Protection & Trip Relay (mS)	Total Time (mS)		Fault Rating (RMS Symmetrical) (3 phase) (MVA)	Fault Break Rating (RMS Symmetrical) (3 phase) (kA)	Fault Break Rating (Peak Asymmetrical) (3 phase) (kA)	Fault Make Rating (Peak Asymmetrical) (3 phase) (kA)	Fault Rating (RMS Symmetrical) (1 phase) (MVA)	Fault Break Rating (RMS Symmetrical) (1 phase) (kA)	Fault Break Rating (Peak Asymmetrical) (1 phase) (kA)	Fault Make Rating (Peak Asymmetrical) (1 phase) (kA)
Site A	120	132KV	BRUSH	DB145	SF6	1991	60	30	90	2500	7202	31.5	59.2	78.8				
				EXAMPLE														

EXAMPLE

Offshore TO Name

Services Capability Specification

Guidance Notes Reference: Part 3 - 2.4 Transformers

HV Node	HV	LV Node	LV	Rating	Transformer	PPS PARAMETERS		ZPS PARAMETERS		Taps			Winding	Earthing		NGET Line Code
						R1	X1	R0	X0	Tap Low	Tap High	Tap Step		Method	Impedance	
						%100MVA	%100MVA	%100MVA	%100MVA	%	%	%				
Name	132	Name	33	90	Grid T1	0.7407	27.2333	0.7407	27.2333	-20	10	1.67	2			T123
					EXAMPLE											

EXAMPLE

Offshore TO Name

Services Capability Specification

Guidance Notes Reference: Part 3 - 2.5 Reactive Compensation Equipment

SWITCHED SHUNT REACTORS

Item	Node	kV	Reactor No.	Rating MVA	P Loss kW	Taps	Connection
1	Name	33	1	1 x 60	240.0	10 taps from 30MVA to 60MVA	LV of 132/33 kV SGT1
		EXAMPLE					

NOTE: Please refer to Substation Operating Guides for details of restrictions on the operation of reactors and tap positions.

EXAMPLE

	CIRCUIT RATING SCHEDULE	NGET Line Code	
Voltage 132kV	Offshore TO Name		Issue Date

CIRCUIT Name from Site A – Site B

		Winter				Spring/Autumn				Summer			
OVERALL CCT RATINGS		%Nom	Limit	Amps	MVA	%Nom	Limit	Amps	MVA	%Nom	Limit	Amps	MVA
Pre-Fault Continuous		84%	Line	485	111	84%	Line	450	103	84%	Line	390	89
Post-Fault Continuous		100%	Line	580	132	100%	Line	540	123	100%	Line	465	106
Prefault load exceeds line pre-fault continuous rating	6hr	95%	Line	580	132	95%	Line	540	123	95%	Line	465	106
	20m		Line	580	132		Line	540	123		Line	465	106
	10m	mva	Line	580	132	mva	Line	540	123	mva	Line	465	106
	5m	125	Line	580	132	116	Line	540	123	100	Line	465	106
	3m		Line	580	132		Line	540	123		Line	465	106
Short Term Overloads	6hr	90%	Line	580	132	90%	Line	540	123	90%	Line	465	106
	20m		Line	580	132		Line	540	123		Line	465	106
	10m	mva	Line	580	132	mva	Line	540	123	mva	Line	465	106
	5m	118	Line	580	132	110	Line	540	123	95	Line	465	106
	3m		Line	580	132		Line	540	123		Line	465	106
Limiting Item and permitted overload values for different times and pre-fault loads	6hr	84%	Line	580	132	84%	Line	540	123	84%	Line	465	106
	20m		Line	590	135		Line	545	125		Line	470	108
	10m	mva	Line	630	144	mva	Line	580	133	mva	Line	495	113
	5m	110	Line	710	163	103	Line	655	149	89	Line	555	126
	3m		Line	810	185		Line	740	170		Line	625	143
	6hr	75%	Line	580	132	75%	Line	540	123	75%	Line	465	106
	20m		Line	595	136		Line	555	126		Line	475	109
	10m	mva	Line	650	149	mva	Line	600	137	mva	Line	510	116
	5m	99	Line	760	173	92	Line	695	159	79	Line	585	134
	3m		Line	885	203		Line	810	185		Line	685	156
	6hr	60%	Line	580	132	60%	Line	540	123	60%	Line	465	106
	20m		Line	605	138		Line	560	128		Line	480	110
	10m	mva	Line	675	155	mva	Line	620	142	mva	Line	530	121
	5m	79	Line	820	187	73	Line	750	172	63	Line	635	145
	3m		Line	985	226		Line	900	206		Line	755	173
6hr	30%	Line	580	132	30%	Line	540	123	30%	Line	465	106	
20m		Line	615	141		Line	570	130		Line	490	112	
10m	mva	Line	710	163	mva	Line	655	150	mva	Line	555	127	
5m	39	Line	895	205	36	Line	820	187	31	Line	690	158	
3m		Line	1110	255		Line	1010	230		Line	845	193	
6hr													
20m													
10m													
5m													
3m													
6hr													
20m													
10m													
5m													
3m													

Notes or Restrictions Detailed

EXAMPLE

Offshore TO Name

Services Capability Specification

Guidance Notes Reference: Part 3 – 3.1 Protection Policy

Date: xx/xx/2009

PROTECTION POLICY

Substation: Wind Farm No1: 132/33kV

Details of Protection Policy:

EXAMPLE

Offshore TO Name

Services Capability Specification

Guidance Notes Reference: Part 3 – 3.2 Protection & Automatic Switching Schedule

Circuit: Site End A – Site End B T1 132kV

Date: xx/xx/2009



Reversion: NO

LINE PROTECTION	SITE END A	SITE END B
1st M.P.		
Back-up Earth Fault		

Telecommunications Routes

PROTECTION SIGNALLING	SITE END A	SITE END B
1st M.P.		

INTERTRIPPING	SITE END A	SITE END B
1st Intertrip	YES	YES

INTERTRIPPING AND PROTECTION UNSTABILISATION INITIATION		SITE END A		SITE END B	
		INTERTRIP	UNSTAB.	INTERTRIP	UNSTAB.
SOURCE	1st & 2nd M.P.				
	Busbar Protection				
	CB Fail Prot				

SYNCHRONISING FACILITIES	SITE END A		SITE END B	
	105	1T0	1T0	
Dead Line Charge.	YES			
Circuit Check Synch.			YES	
Live Circuit Close.				

TRANSFORMER INFORMATION	SITE END A	SITE END B
		N/A
Minimum Trip Load (MVA) (LV EI O/C)		
Co-ordinating Gaps in Protected Zone		

5 DAR SEQUENCE SCHEDULES

REVERSION: NO

1. TRANSIENT LINE FAULT

LOCATION	OPERATION	TIME (Seconds)
SITE END A	Close CB 105 to Dead Line Charge	15 sec
SITE END B	Close CB 1T0 to Circuit Check Synch	20 sec

DCC – Dead Line Charge SCC – Circuit Check Synch

2. TRANSIENT LINE FAULT WITH FERRO RESONANCE

LOCATION	OPERATION	TIME (Seconds)
SITE END A		sec
SITE END B		

3. PERSISTENT LINE FAULT

LOCATION	OPERATION	TIME (Seconds)
SITE END A	Close CB 105 to Dead Line Charge & Trips	15 sec
	Isol 103 opens	sec

4. T1 FAULT AT SITE END A

LOCATION	OPERATION	TIME (Seconds)
SITE END A	Close CB105 to Dead Line Charge & Trips	15 sec
	Isol 113 opens	sec
	Close CB 105 to Dead Line Charge	sec

NOTES

1)

Revision & Date	Author	Reason for revision
Draft		First issue.

EXAMPLE

Offshore TO Name

Services Capability Specification

Guidance Notes Reference: Part 3 – 3.3 Generator Intertrip Schemes

Date: xx/xx/2009

GENERATOR INTERTRIP SCHEMES

Substation: Wind Farm No1: 132/33kV

Details of Generator Intertrip Schemes:

EXAMPLE

Offshore TO Name

Services Capability Specification

Guidance Notes Reference: Part 3 – 3.4 Demand Intertrip Schemes

Date: xx/xx/2009

DEMAND INTERTRIP SCHEMES

Substation: Wind Farm No1: 132/33kV

Details of Demand Intertrip Schemes:

EXAMPLE

Offshore TO Name

Services Capability Specification

Guidance Notes Reference: Part 3 – 4.3 Substation Operational Guide Date: xx/xx/2009

SUBSTATION OPERATIONAL GUIDE

Substation: Wind Farm No1: 132kV

Location Details:

Postal Address:	Telephone Nos.	Map Ref.

National Grid Interface
Generator Interface

EXAMPLE

Offshore TO Name

Services Capability Specification

Guidance Notes Reference: Part 3 – 5.1 Automatic Control Systems Date: xx/xx/2009

AUTOMATIC CONTROL POLICY

Substation: Wind Farm No1: 132/33kV

Details of Automatic Control Policy:

EXAMPLE

Offshore TO Name

Services Capability Specification

Guidance Notes Reference: Part 3 – 5.2 Automatic Control Schemes

Date: xx/xx/2009

AUTOMATIC CONTROL SCHEMES

Substation: Wind Farm No1: 132/33kV

Details of Automatic Control Schemes:

Appendix D: Abbreviations & Definitions

Abbreviations

BETTA British Electricity Trading and Transmission Arrangements
SHETL Scottish Hydro-Electric Transmission Ltd
SIR Supplementary Information Request
SO System Operator
SPT Scottish Power Transmission Ltd
STC SO-TO Code
STCP SO-TO Code Procedure
TO Transmission Owner
OFTO Offshore Transmission Owner
SCS Services Capability Specification

Definitions

STC Definitions Used:

NGET

Party (or Parties)

[Normal Capability Limit](#)

[Operational Capability Limit](#)

[Transmission Services](#)

[Connection Site Specification](#)

Grid Code:

[Operational Diagram](#)

[Demand Control](#)

[Plant](#)

[Apparatus](#)

Definition used from other STCPs:

[Acceptance Certificate](#)

[Decommissioning Report](#)